

Instructions for Use for Qualified Specialists in Orthopaedic Technology System Ankle Joint



NEURO HiSWING

Download: www.fior-gentz.com

Content	Page
1. Information	4
2. Safety Instructions	4
2.1 Classification of the Safety Instructions	4
2.2 All Instructions for a Safe Handling of the System Ankle Joint	4
3. Use	7
3.1 Intended Use	7
3.2 Indication	7
3.3 Contraindication	7
3.4 Qualification	7
3.5 Application	7
3.6 Combination Possibilities with Other System Joints	8
4. Joint Function	8
5. Scope of Delivery	8
6. Load	9
7. Tools for Assembling the System Joint	9
8. Assembly Instructions	9
8.1 Demounting the Functional Unit	10
8.2 Mounting the Functional Unit	10
8.3 Mounting the System Stirrup	10
8.4 Checking the System Joint's Free Movement	11
8.5 Mounting the Spring Unit	11
8.6 Checking the Lever	12
8.7 Securing the Screws	12
9. Adjustment Options on the Orthosis	13
9.1 Setting or Adjusting the Orthosis Alignment and Aligning the Spirit Level	13
9.2 Expanding the Range of Motion	13
9.3 Exchanging the Spring Unit	14
9.4 Reading the Joint Angles	14
10. Notes on the Production of the Orthosis	14
10.1 Connecting to the System Side Bar/System Anchor	14
10.2 Grinding the Orthosis Parts	15
10.3 Mounting the Spirit Level	15



11. Converting the System Ankle Joint	15
11.1 Conversion Options with plug + go Modularity	15
11.2 Conversion with plug + go Modularity	16
11.3 Conversion Options without plug + go Modularity	16
11.3.1 Conversion without plug + go Modularity	16
12. Maintenance	17
12.1 Documentation of Maintenance in the Orthosis Service Passport	18
12.2 Maintenance of the Disc Springs	18
12.3 Replacing the Sliding Washers	18
12.4 Dirt Removal	18
13. Period of Use	19
14. Storage	19
15. Spare Parts	20
15.1 Exploded View Drawing NEURO HiSWING	20
15.2 Spare Parts for the NEURO HiSWING System Ankle Joint	21
15.3 Spring Units	21
15.4 Sliding Washers	22
16. Disposal	22
17. Signs and Symbols	23
18. CE Conformity	23
19. Legal Information	23
20. Information for the Treatment Documentation	24
21. Handing Over the Orthosis	25

1. Information

These instructions for use are addressed to qualified specialists in orthopaedic technology and do not contain any notes about dangers which are obvious to them. To achieve maximum safety, please instruct the patient and/or care team in the use and maintenance of the product.

2. Safety Instructions

2.1 Classification of the Safety Instructions

 DANGER	Important information about a possible dangerous situation which, if not avoided, leads to death or irreversible injuries.
 WARNING	Important information about a possible dangerous situation which, if not avoided, leads to reversible injuries that need medical treatment.
 CAUTION	Important information about a possible dangerous situation which, if not avoided, leads to light injuries that do not need medical treatment.
<i>NOTICE</i>	Important information about a possible situation which, if not avoided, leads to damage of the product.

All serious incidents according to Regulation (EU) 2017/745 which are related to the product have to be reported to the manufacturer and to the competent authority of the Member State in which the qualified specialist in orthopaedic technology and/or the patient is established.

2.2 All Instructions for a Safe Handling of the System Ankle Joint

DANGER

Potential Traffic Accident Due to Limited Driving Ability

Advise the patient to gather information about all safety and security issues before driving a motor vehicle with orthosis. The patient should be able to drive a motor vehicle safely.

WARNING

Jeopardising the Therapy Goal by Not Providing the Necessary Free Movement

Check if the system joint moves freely in order to avoid restrictions of the joint function. Use suitable sliding washers according to the information in these instructions for use.

WARNING

Jeopardising the Therapy Goal Due to Incorrectly Adjusted Spring Units

Screw in the spring unit up to the system stirrup and do not preload the spring unit. If the stops are reached too early or too late, either the range of motion is restricted or the patient is not sufficiently stabilised by the orthosis, which worsens the gait.

WARNING

Risk of Falling Due to Permanent Higher Load

If patient data has changed (e.g. due to weight gain, growth or increased activity), recalculate the expected load on the system joint, plan the treatment again and, if necessary, produce a new orthosis.

WARNING

Risk of Falling Due to Improper Processing

Process the system joint according to the information in these instructions for use. Deviating processing and modifications of the system joint require the written consent of the manufacturer.

WARNING

Risk of Falling Due to Improper Heel Height

Determine with the patient a maximum heel height of the shoes to be worn with the orthosis.

WARNING

Risk of Falling Due to Improper Handling

Inform the patient about the correct use of the system joint and potential dangers especially with regards to:

- moisture and water as well as
- excessive mechanical stress (e.g. due to sports, increased activity or weight gain).

WARNING

Risk of Falling Due to Improper Handling of the Lever

Use the lever as described in these instructions for use. Inform the patient about the proper handling of the lever, especially with regards to:

- pushing the lever all the way up before adjusting the ankle joint angle,
- changing the ankle joint angle with low effort,
- not putting weight on the orthosis when the lever is pushed up (e.g. while walking, running or cycling),
- securing the system joint before putting weight on the orthosis by pushing the lever completely down so it does not protrude.

WARNING

Risk of Falling Due to Loose-Fitting Functional Unit

Mount the functional unit to the system joint according to the assembly instructions in these instructions for use. Secure the screws with the specified torque and the corresponding adhesive and make sure that no sliding washers are damaged in the process.

WARNING

Risk of Falling Due to Incorrectly Mounted Spirit Level

Mount the spirit level on the orthosis according to the assembly instructions in these instructions for use. Please also refer to the online tutorials on the FIOR & GENTZ website or contact Technical Support.

WARNING

Risk of Falling Due to Incorrectly Selected System Components

Make sure that the system joint and the system components are not overloaded and are functionally adapted to the requirements and needs of the patient in order to avoid joint dysfunction.

WARNING

Risk of Falling Due to Use of the Orthosis without a Shoe

If the patient wants to wear the orthosis without a shoe, attach a fixation that holds the foot piece against the foot. Additionally, place a slip-resistant rubber sole under the sole of the foot piece.

WARNING

Damage to the Anatomical Joint Due to Incorrect Position of the Joint's Mechanical Pivot Point

Determine the joint's mechanical pivot points correctly in order to avoid a permanent incorrect load on the anatomical joint. Please refer to the online tutorials on the FIOR & GENTZ website or contact Technical Support.

WARNING

Damage to the System Joint Due to Improper Handling of the Functional Unit

Do not open the hydraulics of the functional unit. Do not loosen the screws of the hydraulics as this will cause damage to the hydraulics.

WARNING

Damage to the System Joint Due to Incorrect Filing

When filing any system components, proceed carefully in order to avoid predetermined breaking points (burrs, edges). Pay attention to the markings.

NOTICE

Damage to the System Joint Due to Improper Handling of the Lever

Use the lever as described in these instructions for use. Otherwise, the hydraulics of the system joint will be damaged. Inform the patient about the proper handling of the lever by means of the **Instructions for Use for Patients NEURO HiSWING**, especially with regards to:

- not putting weight on the orthosis when the lever is pushed up (e.g. while walking, running or cycling) as well as
- adjusting the ankle joint angle only when the lever is pushed all the way up.

NOTICE

Limitation of the Joint Function Due to Improper Processing

Errors in processing can impair the joint function. Pay particular attention:

- correctly connect the system side bar/system anchor with the system case in accordance with the production technique;
- grease the joint components only *slightly* and
- adhere to the maintenance intervals.

NOTICE

Limitation of the Joint Function Due to Improper Dirt Removal

Inform the patient on how to properly remove dirt from the orthosis and the system joint.

NOTICE

Limitation of the Joint Function Due to Lack of Maintenance

Respect the specified maintenance intervals in order to avoid joint dysfunction. Also inform the patient about the maintenance appointments to be respected. Enter the next maintenance appointment in the orthosis service passport of the patient.

3. Use

3.1 Intended Use

The **NEURO HiSWING** system ankle joint is exclusively for use for orthotic fittings of the lower extremity. The system joint is only allowed to be used for producing an AFO or a KAFO. Every system joint influences the orthosis' function and thus also the function of the leg. The system joint may only be used for one fitting and must not be reused.

3.2 Indication

The indications for the treatment with an orthosis for the lower extremity are insecurities that lead to a pathological gait. This can be caused, for example, by paralyses, structurally conditioned deformities/malfunctions or as a result of physical trauma and/or surgery.

The physical conditions of the patient, such as muscle strength or activity level, are crucial for the orthotic treatment. An evaluation regarding the safe handling of the orthosis by the patient must be carried out.

All system ankle joints can also be used for the prosthetic treatment of patients with partial foot amputations. For this purpose, the orthosis produced for the patient by a qualified specialist in orthopaedic technology (custom-made product) is combined with a foot prosthesis. Further information can be found in the **Guide to Partial Foot Amputations** (see QR code, fig. 1).



fig. 1

3.3 Contraindication

The system joint is not suitable for treatments that were not described in paragraph 3.2, such as a treatment of the upper extremity or a treatment with a prosthesis or ortho-prosthesis that affects more than just part of the foot, for example after amputations of leg segments.

3.4 Qualification

The system joint must only be handled by a qualified specialist in orthopaedic technology.

3.5 Application

All **FIOR & GENTZ** system joints were developed for everyday life activities such as standing and walking. Extreme impact stress, which occurs for example during long jump, climbing and parachuting, is excluded.

3.6 Combination Possibilities with Other System Joints

The NEURO HiSWING system ankle joint can be combined with other system joints from the FIOR & GENTZ product range. The system ankle joint NEURO CLASSIC with plug + go modularity can be used as supporting joint.

We recommend that you use the Orthosis Configurator when selecting all system components for your orthosis and follow the recommendations of the configuration result.

4. Joint Function

Due to the used system components, the NEURO HiSWING system ankle joint has the following functions:

System Component	Function
spring units	dorsal (posterior spring unit): - integrated dorsiflexion assist - controlled lowering of the foot during loading response
	ventral (anterior spring unit): - increased energy return during heel lift to support push off
	dorsal and ventral: - dynamically bringing the patient from a bent into an upright position as well as improving the patient's stability while walking and standing by balancing the body
lever	- adjustment of the orthosis alignment by a qualified specialist in orthopaedic technology - modification of the ankle joint angle by the patient, e.g. when the terrain changes - increase of the range of motion by 34°

5. Scope of Delivery

Description	Quantity
system ankle joint incl. functional unit with spirit level (fig. 2)	1
cover plate pressing aid (fig. 3)	1
orthosis joint grease, 3g (without figure)	1
assembly/lamination dummy for system ankle joint (fig. 4)	1
assembly/lamination dummy for spirit level (fig. 5)	1



fig. 2

The corresponding spring units and system stirrups have to be ordered separately.



fig. 3



fig. 4



fig. 5

6. Load

The actual load on the system joints is based on the relevant patient data and the choice of shoes. When selecting the system joint, the maximum heel height of the shoes that the patient wants to wear with the orthosis must be taken into account after consultation with the patient. The load and the appropriate system components can be determined by using the Orthosis Configurator. We recommend that you use the system components determined by the Orthosis Configurator when producing an orthosis and mind the recommended production technique. You will find information on the production techniques in the section "Online Tutorials" on the FIOR & GENTZ website.

7. Tools for Assembling the System Joint

Tools for System Joint Screws	System Width	
	16mm	20mm
T20 hexalobular screwdriver/bit	x	x
T8 hexalobular screwdriver/bit	x	x
torque screwdriver, 1–6Nm	x	x
hexagonal screwdriver with spherical head, 5 x 100mm	x	x
pliers	x	x

Tools for Spirit Level	System Width	
	16mm	20mm
T6 hexalobular screwdriver/bit	x	x

Tools for Pressing Screw	System Width	
	16mm	20mm
T25 hexalobular screwdriver/bit	x	x

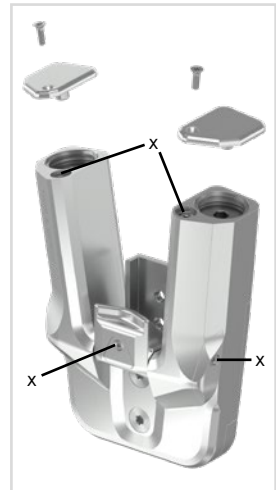

fig. 6

8. Assembly Instructions

The system joint is delivered fully assembled. All functions are checked beforehand. In order to mount the system joint on the orthosis and for maintenance work, you must first remove the functional unit from the system joint. To ensure an optimal function after the assembly, follow the assembly instructions below. Secure all screws with the torque specified in paragraph 8.7.

You can find more information on the assembly in the online tutorial **Joint Assembly System Ankle Joints with plug + go Modularity** (see QR code, fig. 7) on the FIOR & GENTZ website.



fig. 7



The hydraulic system of the functional unit must not be opened. Refer to the exploded view drawings (figs. 44–46) to see which system components of the system joint may be demounted. The screws of the hydraulics marked in fig. 6 must not be loosened.



Only use the FIOR & GENTZ orthosis joint grease to grease the system components.

8.1 Demounting the Functional Unit

- 1 Push the lever on the front of the functional unit upwards.
- 2 Unscrew both countersunk flat head screws.
- 3 Place the washer on the functional unit and screw the pressing screw into the thread of the first screw (S1; fig. 12). The pressing screw must not be screwed in completely (fig. 8).
- 4 Push the joint's upper part and the functional unit apart by exerting force on them as illustrated (arrows in fig. 8). This can be achieved by using a vice or by controlled knocks (e.g. with a soft-faced hammer).
- 5 Remove pressing screw and washer.

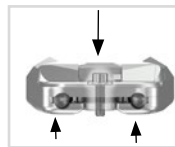

fig. 8



fig. 9

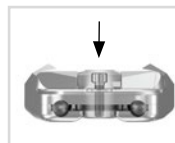

fig. 10



fig. 11



fig. 12



fig. 13



fig. 14

8.2 Mounting the Functional Unit



Make sure not to damage the sliding washer during assembly. Jammed sliding washer particles can cause lateral play in the system joint.

- 1 Before the assembly, clean the thread of the bearing nut and of the joint's upper part as well as the bores of the functional unit with LOCTITE® 7063 Super Clean. Allow the threads to air-dry for 10 minutes.
- 2 Apply spray adhesive on one side of a sliding washer and adhere it to the functional unit (fig. 9).
- 3 Grease the other side slightly with orthosis joint grease.
- 4 Grease the lateral contact surfaces on the functional unit to the joint's upper part with orthosis joint grease.
- 5 Mount the functional unit by pressing it with the pressing screw and the washer (fig. 10).
- 6 Remove pressing screw and washer.
- 7 Screw in the first countersunk flat head screw (S1; fig. 12).
- 8 Make sure that there is no opening left between the functional unit and the joint's upper part (fig. 13).

8.3 Mounting the System Stirrup

- 1 Grease the sliding surfaces of the bearing nut as well as the contact surfaces of the system stirrup between system stirrup and spring units with orthosis joint grease.
- 2 Grease the second sliding washer slightly on both sides and place it on the system stirrup so that there is one sliding washer on each side (fig. 14).

- 3 Slide the system stirrup from below between the functional unit and the joint's upper part. Make sure that the sliding washer remains in the correct position.
- 4 Put the bearing nut into the joint's upper part. The bearing nut must be fully inserted in the opening (fig. 15).
- 5 Screw in the second countersunk flat head screw (axle screw, S2; fig. 16).



fig. 15

8.4 Checking the System Joint's Free Movement

Tighten the screws for the functional unit with the appropriate torque (see paragraph 8.7). Check if the system joint moves freely. If the system joint runs with lateral play, mount the next thicker sliding washer. If it does not move freely (it is jammed), mount the next thinner sliding washer.



fig. 16

8.5 Mounting the Spring Unit

- 1 Loosen the screws on the back of the functional unit and remove both spring unit covers (fig. 17).
- 2 Loosen the screws on top of the spring ducts and remove the adjusting screw covers (fig. 18). The adjusting screws (2) are now visible.
- 3 Unscrew the adjusting screws up to the stop and push the lever (1) on the front of the functional unit downwards (fig. 16).
- 4 Assemble the O-ring dampers (4) and the sliding bushings (5) with the plungers (3; fig. 19). Make sure that the sliding bushings are correctly positioned on the plunger (fig. 20). Apply a drop of orthosis joint grease on top of the O-ring damper.
- 5 Put the coil springs (6) on them.
- 6 Insert the spring units (7) including the plungers (3) and the assembled system components (4, 5, 6) into the spring ducts (fig. 19).
- 7 Screw the adjusting screws back in. Make sure that there is no play in ap direction. The adjusting screws must be screwed in far enough to ensure that there is no more play in ap direction. The spring units must not be compressed.
- 8 Push the lever downwards.
- 9 Replace the spring unit covers on the back of the functional unit (fig. 21) and the adjusting screw covers on the spring ducts.



fig. 17



fig. 18

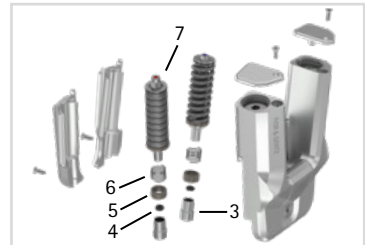

fig. 19

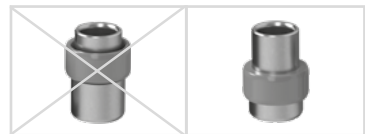

fig. 20



Flip the lever upwards and check the hydraulics after inserting the spring units into the system joint and screwing back in the adjusting screws. If the hydraulics are disturbed (lack of movement in the hydraulics), loosen the adjusting screws slightly.



fig. 21

8.6 Checking the Lever

After mounting the spring units, check the function of the lever.

- 1 Push the lever upwards.
- 2 Move the system joint in ap direction and check if the ankle joint angle can be changed.
- 3 Flip the lever downwards and check if the new ankle joint angle is secured and maintained.

8.7 Securing the Screws

The screws are secured after the orthosis has been produced and tried on and before it is handed over to the patient.

- 1 Loosen the screws for the functional unit (fig. 16) after checking the system joint's free movement and remove them from the functional unit.
- 2 Apply a small drop of LOCTITE® 243 medium strength to the thread of the screws.
- 3 Secure the screws for the functional unit (fig. 16) with the torque corresponding to the system width.
- 4 Let the adhesive harden (final strength after approx. 24 hours).

Screws for Functional Unit	System Width	
	16mm	20mm
pressing screw of the cover plate pressing aid	6Nm	6Nm
countersunk flat head screw with hexalobular socket (S1)	6Nm	6Nm
countersunk flat head screw with hexalobular socket (axle screw, S2)	4Nm	4Nm



The screws of the functional unit are not secured with the necessary torque at delivery. You can also find information on the torque in the openings of the functional unit.

9. Adjustment Options on the Orthosis

The orthosis can be individually adapted to the patient's needs with adjustable system ankle joints. The adjustments described in the paragraphs 9.1 to 9.4 do not influence each other and can be changed separately.



Mind the correct adjustment of the dorsiflexion stop when mounting the system ankle joint. It is decisive for the entire alignment of the orthosis. You can find more information on this in the online tutorial **AFO Alignment Guidelines** (see QR code, fig. 22) on the FIOR & GENTZ website.



fig. 22

9.1 Setting or Adjusting the Orthosis Alignment and Aligning the Spirit Level

With the lever on the functional unit, the ankle joint angle can be infinitely adjusted in both directions by up to 17°. Make all adjustments to the orthosis on the workbench and not on the patient's leg. For this purpose, proceed as follows:

- 1 Place the orthosis in the shoe.
- 2 Push the lever upwards (fig. 23) and bring the orthosis into the desired position (fig. 24).
- 3 Secure the system joint by pushing the lever downwards (fig. 25).



fig. 23



Make sure that the lever is fully pushed down. If it protrudes slightly, the orthosis does not provide the necessary safety. Furthermore, this can cause damage to the hydraulics of the system joint.



fig. 24

- 4 Align the spirit level by using a hexalobular screwdriver. The air bubble must be aligned centrally (fig. 26). If you wish to adapt the orthosis alignment in the course of therapy, start at step 1.



The spirit level (see paragraph 10.3) is positioned so that it indicates the correct orthosis alignment and can later be used by a qualified specialist in orthopaedic technology and the patient as guidance.



fig. 25

9.2 Expanding the Range of Motion

The range of motion of the system joint can be expanded by 34° by flipping the lever upwards. Note that the spring units are not active in this setting.

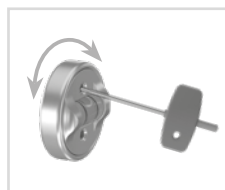

fig. 26



This setting is only suitable for adjusting the ankle joint angle, sitting as well as putting on and taking off the orthosis and must not be used for walking, running or cycling. The orthosis does not provide the patient with the necessary security as its function is disabled in this setting. Furthermore, this can cause damage to the hydraulics of the system joint.

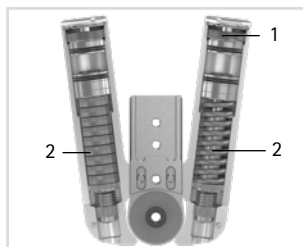

fig. 27

9.3 Exchanging the Spring Unit

The spring force can be changed with spring units (2) in different strengths (fig. 27). Insert a spring unit into the spring duct that corresponds with the required spring force. There are five spring units with spring forces ranging from normal to extra strong (fig. 28). Note that the spring unit determines the maximum possible range of motion of the secured system joint.

In order to replace the spring unit, the adjusting screw (1) must be loosened first (fig. 27). After inserting the new spring unit, the adjusting screw must be screwed in again until the spring unit is mounted without play.

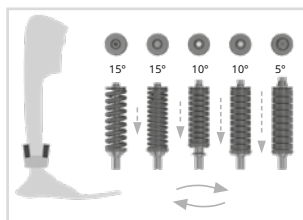

fig. 28

9.4 Reading the Joint Angles

There are markings (fig. 29) on all system joints and system stirrups which indicate the angle of the system components to each other. This allows you to check the individual normal posture (the orthosis' basic alignment), record the joint angle and compare later deviations. The joint angle in the individual normal posture must not be outside the degree markings.

The distances between the degree markings can be seen in the following table.

Degree Marking		
System Width	16mm	20mm
Degree	2°	2°

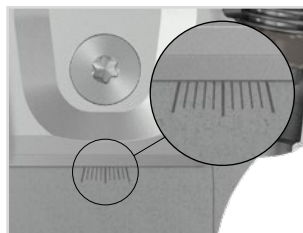

fig. 29

10. Notes on the Production of the Orthosis

10.1 Connecting to the System Side Bar/ System Anchor

The system side bar/system anchor must be connected to the system joint by adhering and screwing or screwing and wrapping in accordance with the production technique provided in the planning (fig. 30–32).



fig. 30



fig. 31



fig. 32

You can find more information in the **Instructions for Use for Qualified Specialists in Orthopaedic Technology System Side Bars and System Anchors** (see QR code, fig. 33).

10.2 Grinding the Orthosis Parts

After tempering the orthosis parts, grind the laminate edges. Be careful not to grind the lateral surfaces of the joint's upper part. This can damage the fit between the joint's upper part and the cover plate, which can lead to mechanical noises and to the breakage of the feather keys with pin. Make sure that the lower edges of the functional unit do not come into contact with the laminate of the foot piece when the lever is flipped upwards, both in full dorsiflexion and full plantar flexion, so that the patient can use the full range of motion.

You will find information on the production techniques in the section "Online Tutorials" on the FIOR & GENTZ website.



fig. 33

10.3 Mounting the Spirit Level

Mount the spirit level laterally on the lower leg shell. You can find more information on this in the online tutorial **Assembly of the Spirit Level of the NEURO HiSWING** (see QR code, fig. 34) on the FIOR & GENTZ website.



fig. 34

11. Converting the System Ankle Joint

If you do not need the conversion options, you can completely file off the noses of the system stirrups along the vertical lines (fig. 37).

11.1 Conversion Options with **plug + go Modularity**

The NEURO HiSWING is designed with **plug + go modularity**. All system ankle joints with **plug + go modularity** have identical system stirrups, joint's upper parts and assembly/lamination dummies and can be easily converted among themselves. All functional differences are in the functional unit. You can find more information on the conversion in the online tutorial **Joint Conversion System Ankle Joints with plug + go Modularity** (see QR code, fig. 35) on the FIOR & GENTZ website. The following system ankle joints are provided with **plug + go modularity**:



fig. 35

- NEURO CLASSIC with **plug + go modularity**
- NEURO VARIO-CLASSIC 2
- NEURO VARIO 2
- NEURO VARIO-SPRING 2
- NEURO VARIO-SWING
- NEURO SWING-CLASSIC
- NEURO SWING
- NEURO SWING 2
- NEURO HiSWING

11.2 Conversion with plug + go Modularity

- 1 Demount the functional unit.
- 2 Mount the functional unit of the desired system joint in the correct system width (see example fig. 36).

When mounting the functional unit, follow the work steps in paragraphs 8 and 10.2.

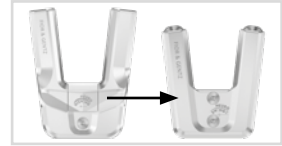

fig. 36

11.3 Conversion Options without plug + go Modularity

The system ankle joint can also be converted into a **NEURO CLASSIC free moving** by optionally filing the system stirrup and by exchanging the functional unit.

11.3.1 Conversion without plug + go Modularity

- 1 File off the noses along the vertical laser lines completely (fig. 37).
However, this is meant only for visual purposes – the function is also given without filing off the noses.
- 2 Demount the functional unit.
- 3 Mount the functional unit of the system joint **NEURO CLASSIC free moving** in the correct system width (see fig. 38).

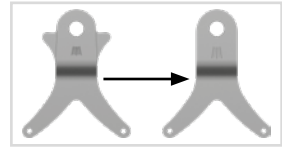

fig. 37



fig. 38

12. Maintenance

Check the system joint regularly for wear and functionality. In particular, check the system components listed in the following table for the possible problems described and, if necessary, take the appropriate measures. Also check the functionality after every maintenance carried out. It must be possible to move the system joint without problems or unusual noises. Make sure that there is no lateral play and no play around the axis.



The hydraulic system of the functional unit must not be opened. Refer to the exploded view drawings (figs. 44–46) to see which system components of the system joint may be demounted.

Joint Component	Potential Problem	Measure	Recommended Inspection, Potential Replacement*	Latest Replacement
O-ring damper**	wear	replacing O-ring damper	every 6 months	every 18 months
O-ring for securing the spring unit	wear	replacing O-ring	every 6 months	every 18 months
spring unit	wear	replacing spring unit	every 6 months	every 18 months
	radial move of disc springs (fig. 41)	realigning disc springs with pliers	every 6 months	every 18 months
	noise of spring unit with coil spring	greasing the coil spring with orthosis joint grease or spray oil (article no. FT3000-15)	every 6 months	every 18 months
	noise of spring unit with disc springs	greasing disc springs laterally with spray oil (article no. FT3000-15)	every 6 months	every 18 months
coil spring**	wear	replacing coil spring	every 6 months	every 18 months
sliding bushing (plunger)**	wear	replacing sliding bushing	every 6 months	every 18 months
sliding bushing (system stirrup)	wear	replacing sliding bushing	every 6 months	every 18 months
sliding washer	wear	replacing sliding washer, see paragraph 12.3	every 6 months	every 18 months
countersunk flat head screw with hexalobular socket**	wear	replacing countersunk flat head screw	every 6 months	every 36 months
bearing nut	wear	replacing bearing nut	every 6 months	every 36 months
feather key with pin	breakage	replacing feather keys	every 6 months	every 36 months
plunger**	wear	replacing plunger	every 6 months	every 36 months
functional unit	wear or loss of function	replacing functional unit	every 6 months	every 36 months
system stirrup	wear or breakage	replacing system stirrup	every 6 months	every 48 months

* depending on the assessment of the distributor of the custom-made product regarding the patient's usage behaviour

** is part of the functional unit

Clean the thread of the bearing nut and of the joint's upper part as well as the bores of the functional unit with LOCTITE® 7063 Super Clean at every maintenance. Allow the threads to air-dry for 10 minutes.

Secure the screws for the functional unit with the corresponding torque and LOCTITE® 243 medium strength during every maintenance (see paragraph 8.7). Remove all adhesive residues first.

You can find the individual maintenance plans for system joints in the download area (see QR code, fig. 39) on the FIOR & GENTZ website.



fig. 39

12.1 Documentation of Maintenance in the Orthosis Service Passport

The patient receives an orthosis service passport (fig. 40) from a qualified specialist in orthopaedic technology when the orthosis is handed over. The orthosis must be checked regularly according to the specifications in the maintenance plan in order to maintain its function and to ensure the safety of the patient. The maintenance appointments are noted and confirmed in the orthosis service passport.



fig. 40

12.2 Maintenance of the Disc Springs

Check the disc springs particularly carefully during maintenance. We recommend that you grease the disc springs laterally with spray oil (article no. FT3000-15) during every maintenance and realign them, if necessary, to increase the useful life of the spring unit. If necessary, replace the spring unit to maintain the functionality of the system joint.

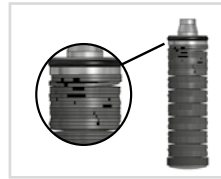

fig. 41

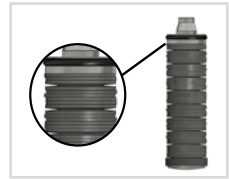

fig. 42

12.3 Replacing the Sliding Washers

Sliding washers are available in different thicknesses (e.g. GS1407-040 is 0.40mm thick). Each thickness has a different marking (fig. 43). You will find the article numbers of the premounted sliding washers on the back page of these instructions for use.

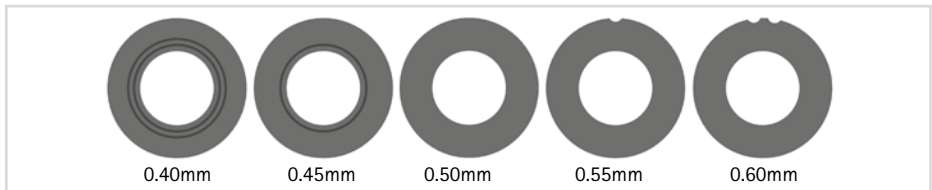

fig. 43

12.4 Dirt Removal

Dirt must be removed from the system joint when necessary and during regular maintenance. For this purpose, disassemble the system joint and clean the soiled system components with a dry cloth.

13. Period of Use

To guarantee a safe use and complete functionality as well as an unlimited period of use of the system joints, you must adhere to the following conditions:

- 1 Adhere to the specified maintenance intervals without interruption and document each maintenance (see paragraph 12).
- 2 Adhere to the determined maintenance conditions (see paragraph 12).
- 3 Check the wear parts, as required, and exchange them in the defined intervals (see paragraph 12).
- 4 Check the adjustment of the system joint during maintenance and correct it, if necessary (see paragraph 12).
- 5 Check the functionality of the system joint during maintenance (see paragraph 12).
- 6 The maximum load determined during the planning of the custom-made product shall not be exceeded by changes in the patient data (e.g. due to weight gain, growth or increased activity). If the determined maximum load on the system joint is exceeded, the system joint must no longer be used. When planning the custom-made product, expected changes in patient data need to be taken into account.
- 7 The period of use of the system joints ends with the period of use of the custom-made product (orthosis).
- 8 The multiple use of the system joint in another custom-made product is not allowed (see paragraph 19).

14. Storage

It is recommended to store the system joint in its original packaging until the custom-made product is produced.

15. Spare Parts

15.1 Exploded View Drawing NEURO HiSWING

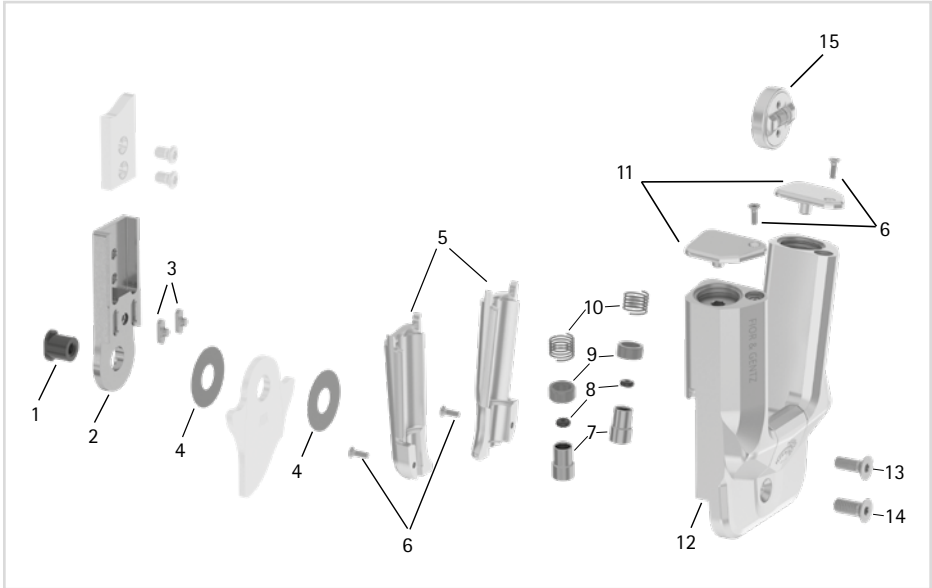

fig. 44

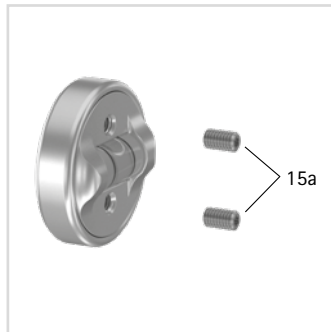

fig. 45



fig. 46

All system stirrups of the system ankle joints are delivered with an integrated sliding bushing.

15.2 Spare Parts for the NEURO HiSWING System Ankle Joint

Item	Article Number for System Width		Description
	16mm	20mm	
1	SB9669-L0760	SB1069-L0960	bearing nut
2-3	SF0313-P/TI	SF0315-P/TI	upper part with feather keys, straight, titanium
2-3	SF0333-P/TI	SF0335-P/TI	upper part with feather keys, bent inwards, titanium
2-3	SF0333-8P/TI	SF0335-8P/TI	upper part with feather keys, bent outwards, titanium
3	SF0393-02	SF0395-01	feather key with pin
4	GS2210-*	GS2611-*	sliding washer*
5	SH0763-2/L	SH0765-2/L	spring unit cover, left lateral or right medial
5	SH0763-2/R	SH0765-2/R	spring unit cover, left medial or right lateral
6	SC1403-L08/1	SC1403-L08/1	countersunk flat head screw with hexalobular socket
7	SH0493-01	SH0493-01	plunger
8	VE3771-012/26	VE3771-012/26	O-ring damper
9	GS1108-500	GS1108-500	sliding bushing
10	FE1027-01	FE1027-01	coil spring
11	SH0763-3/L	SH0765-3/L	adjusting screw cover, left lateral or right medial
11	SH0763-3/R	SH0765-3/R	adjusting screw cover, left medial or right lateral
12	-	-	cover plate
13	SC1405-L12	SC1405-L14	countersunk flat head screw with hexalobular socket
14	SC1405-L12	SC1406-L14	countersunk flat head screw with hexalobular socket (axle screw)
5-14	SH7973-AL**	SH7975-AL	functional unit plug + go modularity
15	SH7805	SH7805	spirit level
15a	SC9403-L05	SC9403-L05	securing pin

15.3 Spring Units

Item	Article Number for System Width		Description
	16mm	20mm	
16	SH5803-15/07	SH5805-15/18	spring unit, blue, normal, max. 15° range of motion
16	SH5803-15/15	SH5805-15/25	spring unit, green, medium, max. 15° range of motion
16	SH5803-10/21	SH5805-10/40	spring unit, white, strong, max. 10° range of motion
16	SH5803-10/31	SH5805-10/60	spring unit, yellow, very strong, max. 10° range of motion
16	SH5803-05/63	SH5805-05/99	spring unit, red, extra strong, max. 5° range of motion
16a	VE3771-08/10	VE3771-11/10	O-ring for securing the spring unit

15.4 Sliding Washers

* Sliding Washers	
Article Number for System Width	
16mm	20mm
Ø = 22mm	Ø = 26mm
GS2210-040	GS2611-040
GS2210-045	GS2611-045
GS2210-050	GS2611-055
GS2210-055	GS2611-050
GS2210-060	GS2611-060

16. Disposal

Dispose of the system joint and its individual parts properly. The product must not be disposed of with the residual waste (fig. 47). Please comply with the applicable national laws and local regulations for the proper recycling of recyclable materials.



fig. 47



For proper disposal, it is necessary to demount the system joint from the orthosis.

17. Signs and Symbols



CE labelling according to Regulation (EU) 2017/745 for medical devices



medical device



article number



manufacturer



batch code



follow the instructions for use



single patient – multiple uses



Unique Device Identifier – product identification number

18. CE Conformity

We declare that our medical devices as well as our accessories for medical devices are in conformity with the requirements of Regulation (EU) 2017/745. Therefore, the FIOR & GENTZ products bear the CE marking.

19. Legal Information

With the purchase of this product, our General Terms and Conditions of Business Transactions, Sales, Delivery and Payment will apply. The warranty expires, for example, if the product is mounted several times. Please note that the product is not supposed to be combined with other components or materials than with those recommended in the configuration result of the FIOR & GENTZ Orthosis Configurator. The combination of the product with products from other manufacturers is not permitted.

The information in these instructions for use is valid at the date of printing. The contained product information serves as guidelines. Subject to technical modifications.

All copy rights, particularly the distribution, copy and translation of these instructions for use or any part of them, must be authorised by FIOR & GENTZ Gesellschaft für Entwicklung und Vertrieb von orthopädiotechnischen Systemen mbH. Reprints, copies and any other electronic reproduction, even partial, must be authorised in writing by FIOR & GENTZ Gesellschaft für Entwicklung und Vertrieb von orthopädiotechnischen Systemen mbH.

.....

20. Information for the Treatment Documentation

Add these instructions for use to your treatment documentation!

Patient Data

Name	
Address	
Postcode, City	
Home Telephone	
Telephone at Work	
Insurance	
Insurance No.	
Attending Physician	
Diagnosis	

21. Handing Over the Orthosis

The qualified specialist in orthopaedic technology has also handed over the instructions for use for patients as well as the orthosis service passport to you as a patient, parent or care team. By means of these instructions for use, the functions and handling of the orthosis were explained to you in detail. You will find the next maintenance appointment in the orthosis service passport. Bring the orthosis service passport with you to every maintenance appointment.



Place, Date

Signature Patient

Heel Height Considered when
Selecting the System Joint:

_____ mm

The patient was informed about the
maximum heel height to be used.

Leg Side

left right

Mounted Sliding Washer

1. GS _____ - _____

2. GS _____ - _____

