

patient commission/configuration ID _____

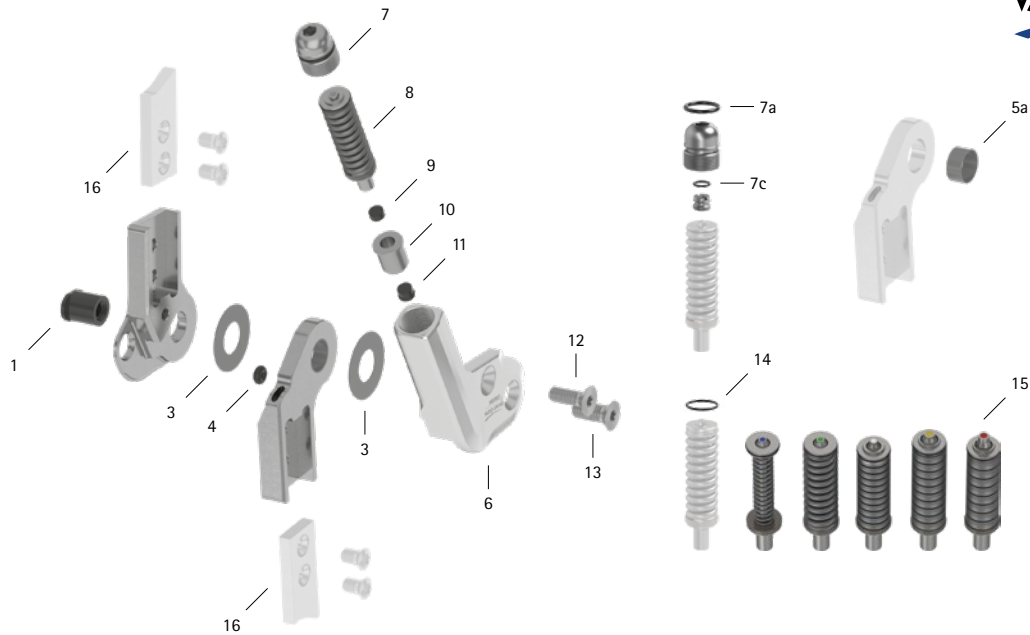

Item	20mm	Description	Potential Problem	Measure	Recommended Inspection, Potential Replacement*	Latest Replacement after
System Joint						
1	SB1069-L1220	bearing nut	wear	replacing	every 6 months	36 months
3	GS2611-040	sliding washer, Ø = 26mm	wear	replacing	every 6 months	18 months
3	GS2611-045					
3	GS2611-050					
3	GS2611-055					
3	GS2611-060					
4	VE3771-012/26	O-ring damper	wear	replacing	every 6 months	6 months
5a	BP1211-L060	sliding bushing	wear	replacing	every 6 months	18 months
6	SL0265-L/AL	cover plate, left lateral or right medial, aluminium**	wear	replacing	every 6 months	36 months
6	SL0265-R/AL	cover plate, left medial or right lateral, aluminium**	wear	replacing	every 6 months	36 months
7a	VE3771-11/15	O-ring for securing the alignment screw**	wear	replacing	every 6 months	6 months
7c	VE3771-04/10	O-ring for securing the motion limiting screw**	wear	replacing	every 6 months	18 months
9	PN0006-L02	stop damper**	wear	replacing	every 6 months	6 months
11	SL0285-06	extension stop**	wear	replacing	every 6 months	if required
12	SC1405-L14	countersunk flat head screw with hexalobular socket**	wear	replacing	every 6 months	36 months
13	SC1406-L14	countersunk flat head screw with hexalobular socket (axle screw)**				
6-13	SL2955-L	functional unit plug + go modularity, left lateral or right medial***	loss of function, wear	replacing	every 6 months	36 months
6-13	SL2955-R	functional unit plug + go modularity, left medial or right lateral***				
Spring Units						
14	VE3771-08/10	O-ring for securing the spring unit	wear	replacing	every 6 months	6 months
15	SH5803-15/07	spring unit, blue, normal, max. 15° range of motion	wear radial move of disc springs noise of spring unit with coil spring noise of spring unit with disc springs	replacing realigning disc springs with pliers greasing the coil spring with orthosis joint grease or spray oil (article no.: FT3000-15) greasing disc springs laterally with spray oil (article no.: FT3000-15)	every 6 months	18 months
15	SH5803-15/15	spring unit, green, medium, max. 15° range of motion				
15	SH5803-10/21	spring unit, white, strong, max. 10° range of motion				
15	SH5803-10/31	spring unit, yellow, very strong, max. 10° range of motion				
15	SH5803-05/63	spring unit, red, extra strong, max. 5° range of motion				
System Anchors and System Side Bars						
16	see catalogue	system anchor and system side bar	wear or breakage	replacing	every 6 months	if required

* depending on the assessment of the distributor of the custom-made product regarding the patient's usage behaviour

** is part of the functional unit

*** included system components can be exchanged separately

WP0087-GB-2023-01