

patient commission/configuration ID _____

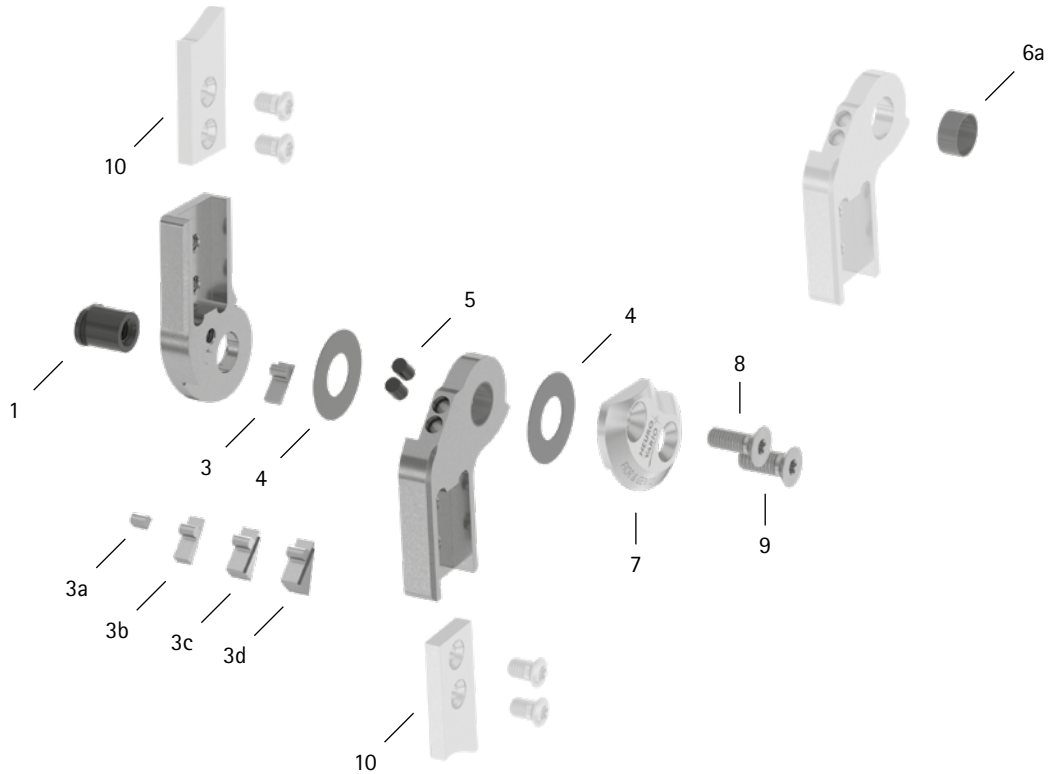
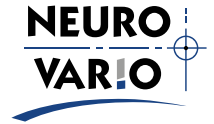

Item	16mm	Description	Potential Problem	Measure	Recommended Inspection, Potential Replacement*	Latest Replacement after
System Joint						
1	SB1069-L1060	bearing nut	wear	replacing	every 6 months	36 months
3a	SJ9023-E000	0° extension stop	wear	replacing	every 6 months	if required
3	SK9523-E005	5° extension stop				
3b	SK9523-E010	10° extension stop				
3c	SK9523-E020	20° extension stop				
3d	SK9523-E030	30° extension stop				
4	GS2311-040	sliding washer, Ø = 23mm	wear	replacing	every 6 months	18 months
4	GS2311-045					
4	GS2311-050					
4	GS2311-055					
4	GS2311-060					
5	PN1000-L05/5	extension stop damper	wear	replacing	every 6 months	18 months
6a	BP1211-L055	sliding bushing	wear	replacing	every 6 months	18 months
7	SK0193-L/AL	cover plate, left lateral or right medial, aluminium	wear	replacing	every 6 months	36 months
7	SK0193-R/AL	cover plate, left medial or right lateral, aluminium				
8	SC1405-L14	countersunk flat head screw with hexalobular socket	wear	replacing	every 6 months	36 months
9	SC1406-L14	countersunk flat head screw, hexalobular socket (axle screw)				
System Anchors and System Side Bars						
10	see catalogue	system anchor and system side bar	wear or breakage	replacing	every 6 months	if required

* depending on the assessment of the distributor of the custom-made product regarding the patient's usage behaviour

WP0079-GB-2024-04